

EXTREMI**FIX**TM

Cannulated Screw System | **MIDSIZE** | **LARGE**

Surgical Technique Guide

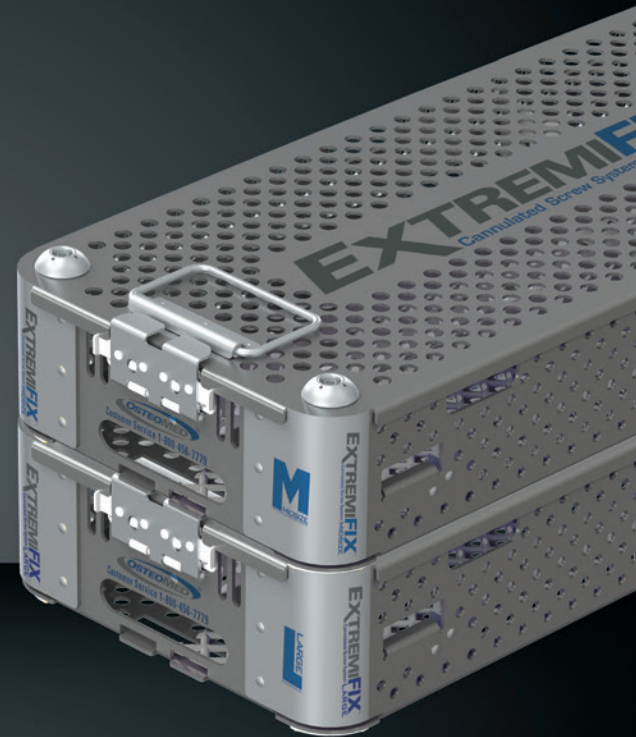
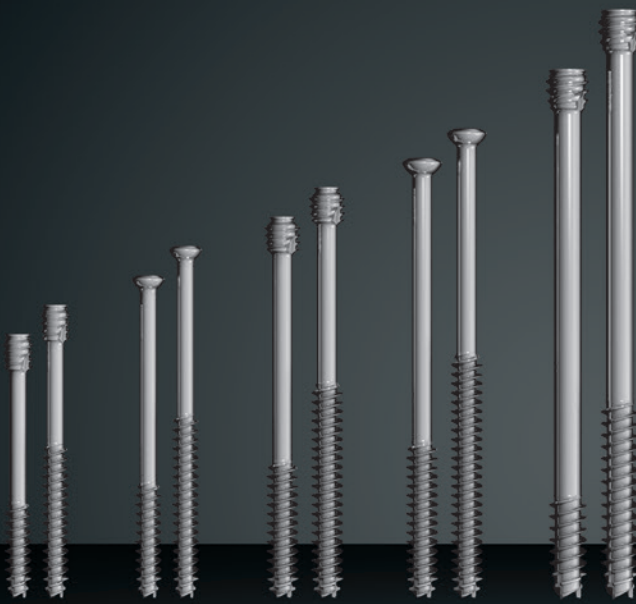
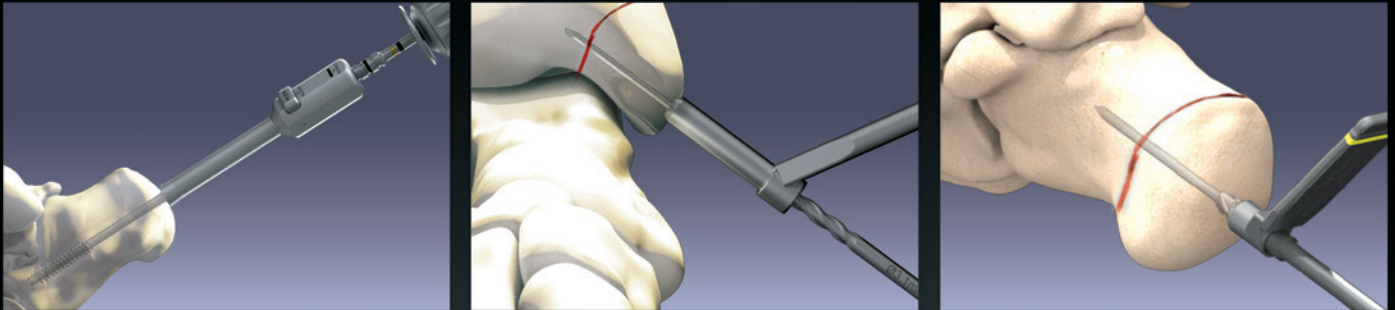

Rethinking Possibilities, Reshaping Lives

Table of Contents

Introduction	2-6
Product information	2
ExtremiFix Midsize Large Screw Offering	2
Headless Screw Characteristics	3
Design Features & Benefits	3
Instrumentation Technical Details	4-6
Calibrated Drill Bits	4
Countersinks	4
Color Coding	4
Screw Measurement	5
Taps	5
Headless Screw Reduction Tool	5-6
Indications	7
Indications, Contraindications, and Warnings	7
Surgical Technique	8-14
Medial Malleolar Fracture	8-11
Calcaneal Osteotomy	12-14
Ordering Information	15-24
Implants	15-17
Midsize Implants	15-16
Large Implants	17
Instrumentation	18-22
Midsize Instruments	18-20
Large Instruments	20-22
Surgical Tray	23-24
Midsize Tray	23
Large Tray	24

Introduction

Product Information

The **ExtremiFix Midsize I Large** Cannulated Screw system offers screws in 4.5 mm, 5.5 mm and 6.5 mm thread diameters, multiple thread options and a variety of lengths providing a wide range of options to treat multiple applications of the midfoot, hindfoot and ankle. The screws are offered in headed and headless options and include the latest screw technology for a reliable and stable fixation of various bones and bone fragments.

The **ExtremiFix Midsize I Large** Cannulated Screw's unique design allows for controlled compression on both headed and headless screws. The headless screws can be used alone generating 2 mm of interfragmentary compression, or used in conjunction with the system's reduction tool allowing unlimited controlled compression.

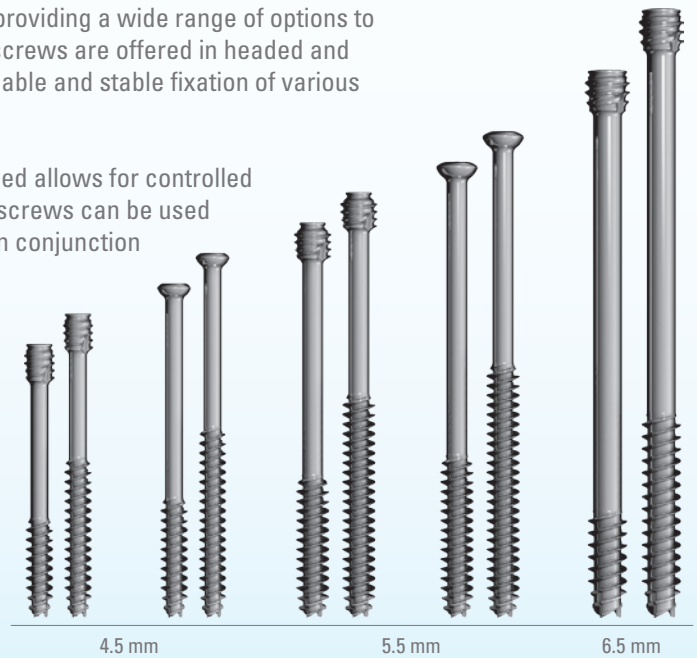

ExtremiFix Midsize | Large Screw Offering

SIZE	4.5 mm		5.5 mm		6.5 mm	
MATERIAL	Titanium					
SCREW TYPE	Headed & Headless				Headless	
THREAD	SHORT 1/3 Thread	LONG 1/2 Thread	SHORT 1/3 Thread	LONG 1/2 Thread	SHORT 16 mm Thread	LONG 32 mm Thread
LENGTH	20-50 mm each 2 mm 55-70 mm each 5 mm	40-50 mm each 2 mm 55-70 mm each 5 mm	20-50 mm each 2 mm 55-80 mm each 5 mm	40-50 mm each 2 mm 55-80 mm each 5 mm	40-120 mm each 5 mm	40-120 mm each 5 mm
GUIDE WIRE	1.6 x 180 mm				2.8 x 230 mm	
PILOT DRILL	3.1 mm		3.7 mm		4.8 mm	



Washers

The ExtremiFix Midsize Cannulated Screw system includes washers for use with 4.5mm and 5.5mm headed screws. Washers may be used to provide additional contact area in patients with soft bone. The washers are laser marked to indicate which side must be in contact with the screw head.

Introduction

Headless Screw Characteristics

The ExtremiFix Midsize I Large headless screw compression is achieved as a result of the different thread pitch between the distal and proximal threads. The screws have been designed to generate 2mm of compression when fully inserted.

2 mm of Built-In Compression

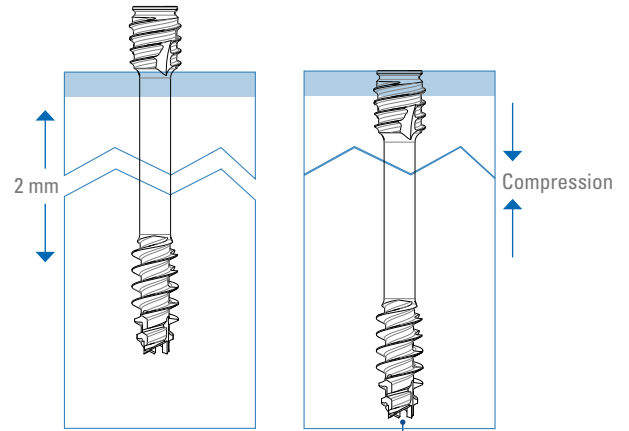
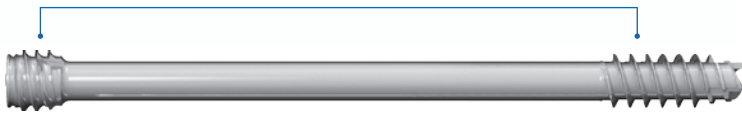

The distal thread design has a greater pitch compared to the proximal thread allowing the screw to advance faster within the distal bone segment with each revolution.

Design Features & Benefits

Reverse Cutting Flutes
Ease of removal

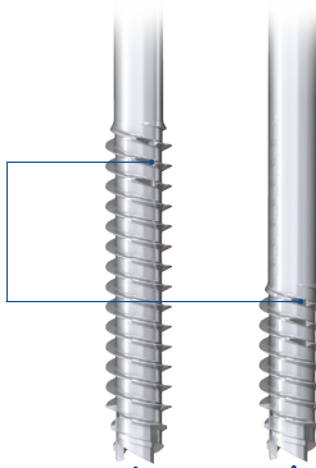

Short and Long Thread Options
Wide range screw offering

Double Lead Screws
Faster insertion,
reduced OR time

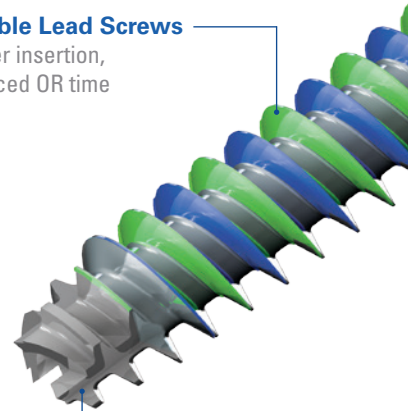

Self Retaining Hexalobe Drive Recess T15, T30
Ease of use and higher torque resistance



Self Drilling and Self Tapping
Ease of insertion

Instrumentation Technical Details

Calibrated Drill Bits

The ExtremiFix Midsize I Large Cannulated Screw system drill bits include color coded bands based on screw diameter and measurement calibrations every 10 mm. These measurements can be used for quick reference and should be read relative to the bone surface.



Countersinks

The ExtremiFix Midsize I Large Cannulated Screw system provides countersinks for both headed and headless screws. The countersinks include color coded bands based on the screw diameter and laser marks to denote screw head height. The countersinks should be used manually.

Headed Screw Option

The countersink should be inserted into the bone until the laser mark is flush with the bone surface.

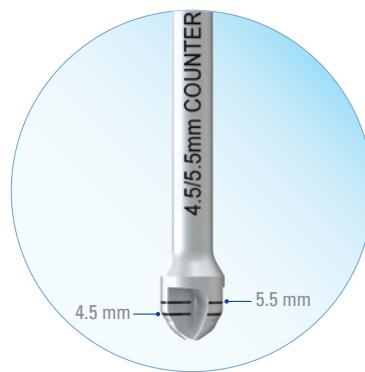

Headless Screw Option

The proximal cortex drill should be inserted into the bone until the laser mark is flush with the bone surface.

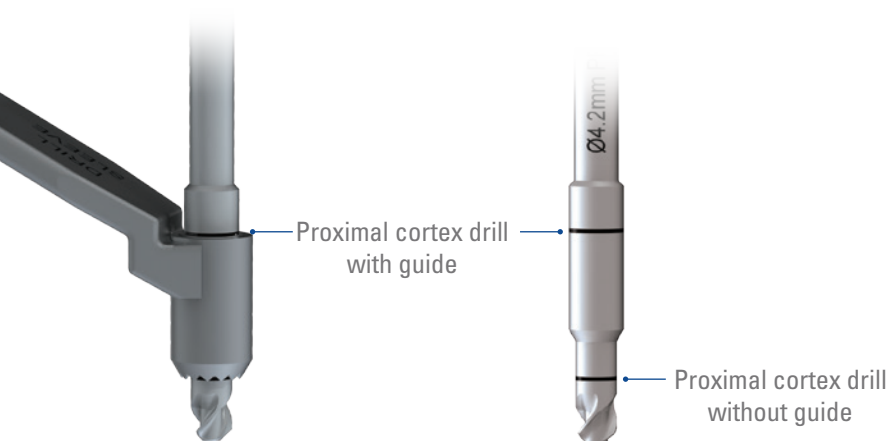

Color Coding

The ExtremiFix Midsize I Large Cannulated Screw system instrumentation includes color coded bands based on screw diameter for easy identification.

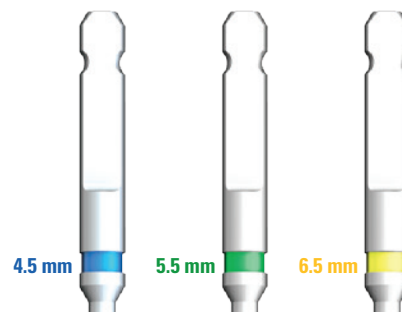

Instrumentation Technical Details (Cont.)

Screw Measurement

Perpendicular Measurement

When measurements are taken perpendicular to the surface of the bone, subtract anticipated interfragmentary screw compression from overall depth gauge reading.

NOTE: In case of angulated measurement, subtract distance from anticipated interfragmentary screw compression and depth gauge positioning.

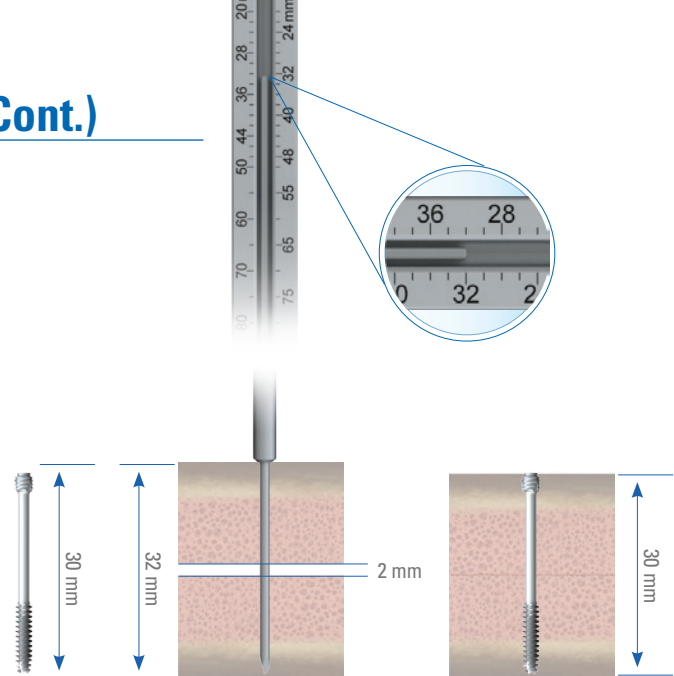

Taps

ExtremiFix Midsize I Large Cannulated Screw system taps include color coded bands based on screw diameter. The taps are recommended in patients with dense cortical bone and should be used manually.



Headless Screw Reduction Tool

The ExtremiFix Midsize I Large headless screw can be used alone generating 2 mm of Interfragmentary compression, or in conjunction with the system's reduction tool allowing unlimited controlled compression.

Lag Technique using Headless Screws

1. Screw Engagement

Place reduction tool over the screw head to engage screw. Once engaged, hold reduction tool sleeve stationary and rotate reduction tool driver shaft counterclockwise to secure the head of screw within the distal end of the tool.

The tool push button will click and pop up once the screw is secured.



Instrumentation Technical Details (Cont.)

2. Screw Insertion

Insert the screw into the bone until the distal tip of the reduction tool comes into contact with the bone.

Optional - The screw insertion can be performed under power. Attach the reduction tool AO connector to the power tool. Insert the screw into the bone and stop before the reduction tool sleeve touches the bone. Reduction should be done manually using the ratcheting handle.

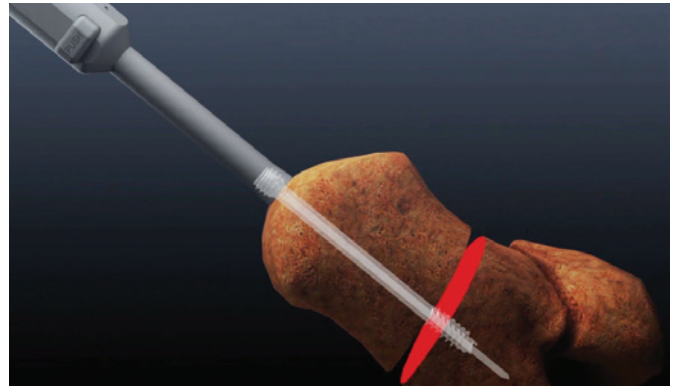

3. Closure of Gap (Lag Screw Technique)

Once the tip of the reduction tool lies on the bone, continue driving the screw (using a lag screw technique) until the fracture gap is closed.

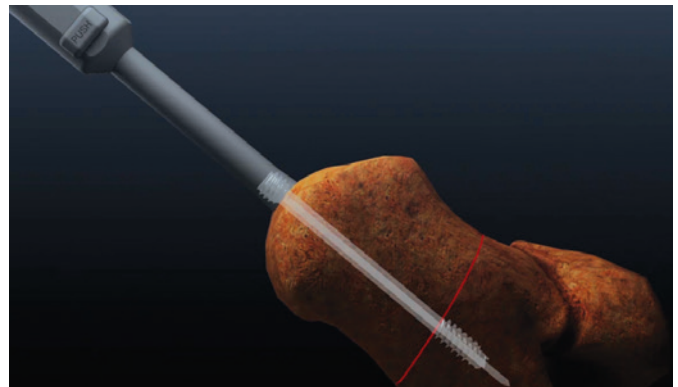

4. Countersinking and Compression

Once the closure of the fracture gap is achieved, press the PUSH button, hold the reduction tool sleeve, and continue to advance the screw clockwise until the screw is flush with the bone surface (2 mm of compression will be generated when countersinking the screw.)

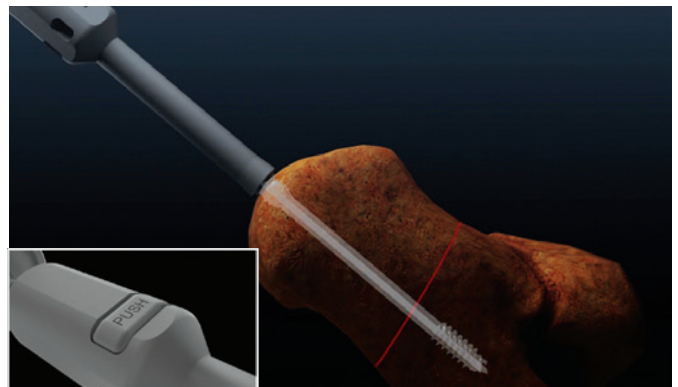

5. Disengaging the Screw

Rotate outer sleeve counterclockwise to expose the distal screw retention interface and disengage the screw head from the driver.

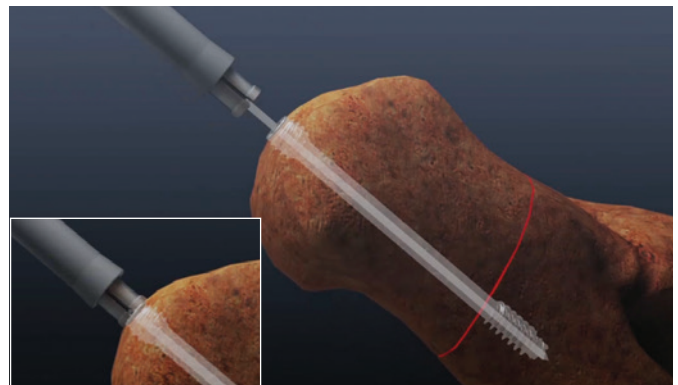

Indications

The OsteoMed ExtremiFix Midsize I Large Cannulated Screw system is indicated for use in bone reconstruction, osteotomy, arthrodesis, and fracture fixation of foot, ankle, and long bones (upper and lower extremity).

Contraindications

Use of the OsteoMed ExtremiFix Midsize I Large Cannulated Screw system is contraindicated in cases of active or suspected infection or in patients who are immunocompromised; in patients previously sensitized to titanium; or in patients with certain metabolic diseases. It is further contraindicated in patients exhibiting disorders which would cause the patient to ignore the physician's pre- and/or post-operative instructions and/or the limitations of internal rigid fixation implants.

Warnings

1. Re-operation to remove or replace implants may be required at any time due to medical reasons or device failure. If corrective action is not taken, complications may occur.
2. Use of an undersized screw in areas of high functional stresses may lead to implant fracture and failure.
3. Plates and screws, wires, or other appliances of dissimilar metals should not be used together in or near the implant site.
4. Instruments, guide wires, and screws are to be treated as sharps.
5. It is recommended to remove any fractured implants and/or instruments from patients during surgery. If unable to remove, notify patient.
6. Use of screws in high density bone may result in implant and/or instrument fracture or failure upon insertion.
7. The OSTEOMED ExtremiFix Midsize & Large Cannulated Screw system is recommended for use in patients with sufficient bone quality to sustain effectiveness and benefits of rigid fixation.
8. The user should be aware of possible allergic reactions to materials used in the device. The patient should be informed on this matter by the user.
9. Failure to follow instructions may result in device not operating as intended.
10. Failure to follow sterilization parameters may result in device not operating as intended.

Surgical Technique

Medial Malleolar Fracture

1. Insert Guide Wire

Place the guide wire/drill guide through a stab incision and insert the guide wire into the bone to the appropriate depth. Use image intensification to verify the guide wire placement. Proper position of guide wire is critical for screw placement.

When placing more than one screw, ensure that subsequent guide wires do not interfere with other implants.

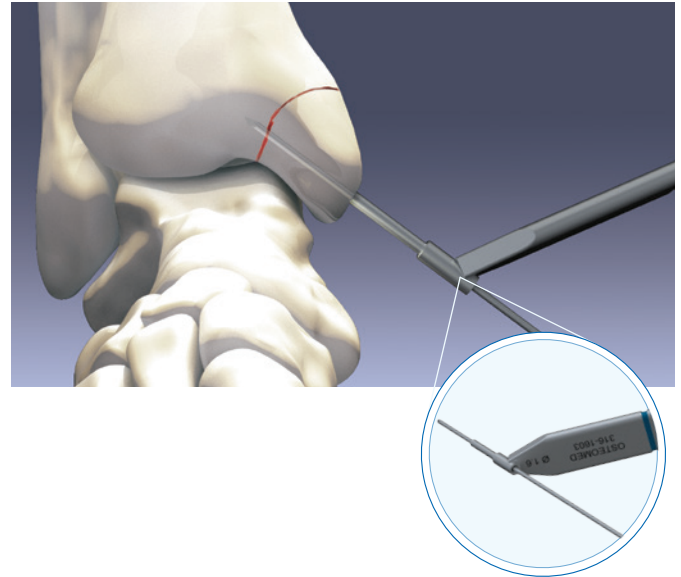

4.5 mm Screws

Part Number	Description
316-1601	1.6 mm x 180 mm Smooth Guide Wire
316-1602	1.6 mm x 180 mm Threaded Guide Wire
316-1603	1.6 mm/3.1 mm Guide Wire/Drill Guide

5.5 mm Screws

316-1601	1.6 mm x 180 mm Smooth Guide Wire
316-1602	1.6 mm x 180 mm Threaded Guide Wire
316-1618	1.6 mm/3.7 mm Guide Wire/Drill Guide

2. Screw Length Measurement

Place depth gauge over the guide wire until the depth gauge tip is positioned directly against the bone. The proximal end of the guide wire will indicate the screw length required. Subtract any anticipated interfragmentary compression resulting from screw insertion.

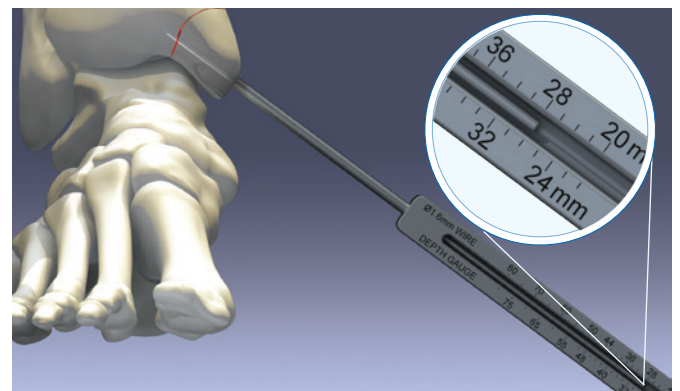

4.5 mm Screws and 5.5 mm Screws

316-1601	1.6 mm x 180 mm Smooth Guide Wire
316-1602	1.6 mm x 180 mm Threaded Guide Wire
316-1614	4.5/5.5 mm Depth Gauge

Surgical Technique

Medial Malleolar Fracture (Cont.)

3. Pre-drilling and Tapping (Optional)

The ExtremiFix Midsize I Large Cannulated Screws are self-drilling and self-tapping. In dense cortical bone, pre-drilling and tapping is recommended.

Place the guide wire/drill guide over the guide wire and drill to the desired depth. Drilling should not go beyond the tip of the guide wire.

When tapping, insert the cannulated bone tap over the guide wire and manually rotate the bone tap until desired depth is reached.

Note: The proximal cortex drill sleeve has been designed to nest with the guide wire/drill guide. Contersinking can be performed with or without the proximal cortex drill sleeve. If using the proximal cortex drill sleeve, assemble the proximal cortex sleeve and guide wire/drill guide prior to drilling.

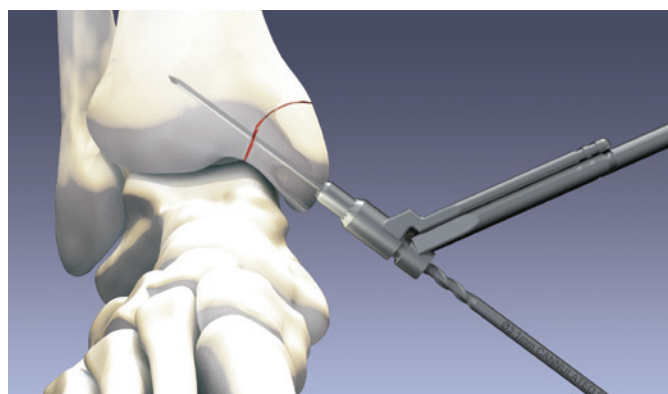
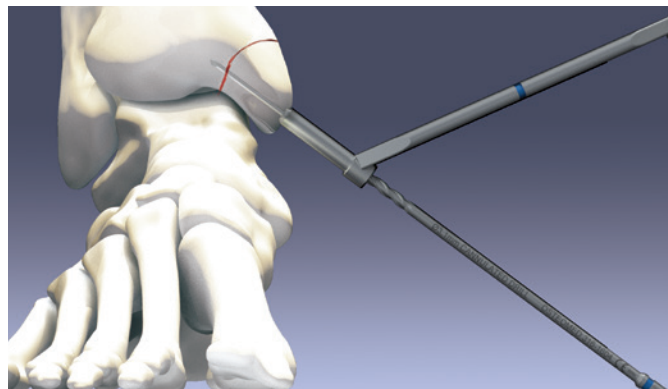

Optional - Proximal cortex drill sleeve and guide wire/drill guide assembly.

4.5 mm Screws

Part Number	Description
316-1603	1.6 mm/3.1 mm Guide Wire/Drill Guide
316-1604	3.1 mm Cannulated Drill, Standard AO Quick Release
316-1612	4.5 mm Cannulated Tap, Standard AO Quick Release
316-1621	4.5/5.5 mm Proximal Cortex Drill Sleeve

5.5 mm Screws

316-1618	1.6 mm/3.7 mm Guide Wire/Drill Guide
316-1605	3.7 mm Cannulated Drill, Standard AO Quick Release
316-1613	5.5 mm Cannulated Tap, Standard AO Quick Release
316-1621	4.5/5.5 mm Proximal Cortex Drill Sleeve

Surgical Technique

Medial Malleolar Fracture (Cont.)

4. Countersinking

Countersinks are available for both headed and headless screws. Countersinking should be performed manually. Place the cannulated countersink or proximal cortex drill over the guide wire to create a recess on the proximal cortex.

Note: Overall screw length is measured from the top of the screw head to the tip of the screw. The head height should be considered when countersinking.

Note: Refer to page 4 regarding countersink options for headed and headless screws and technical details.

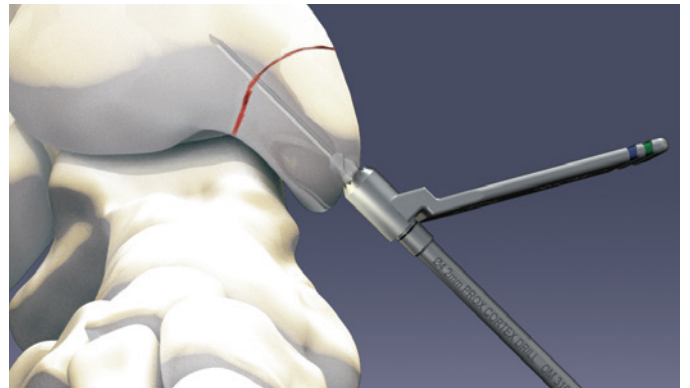
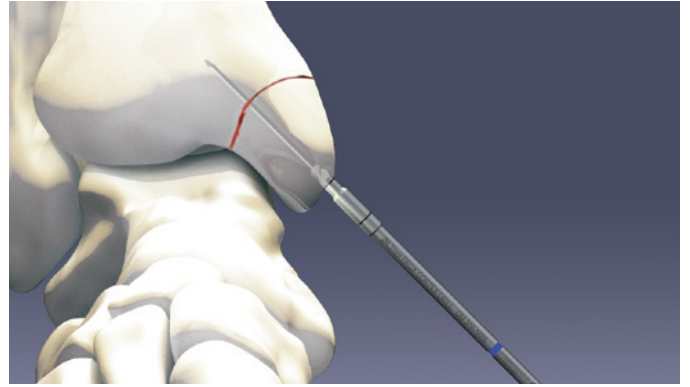

Optional - Proximal cortex drill used with the Proximal cortex drill sleeve.

4.5 mm and 5.5 mm Headless Screws

Part Number	Description
316-1608	4.2 mm Cannulated Proximal Cortex Drill, Standard AO Quick Release
316-1609	5.1 mm Cannulated Proximal Cortex Drill, Standard AO Quick Release
316-1621	4.5/5.5 mm Proximal Cortex Drill Sleeve

4.5 mm and 5.5 mm Headed Screws

316-1610	4.5/5.5 mm Cannulated Countersink, Standard AO Quick Release
----------	--

Surgical Technique

Medial Malleolar Fracture (Cont.)

5. Screw Placement

Select the appropriate screw length and insert screw over the guide wire using the cannulated driver stem and ratcheting handle. Advance the screw head until fully seated with the surface of the bone.

When inserting headless screws in an oblique orientation, it may be necessary to drive the screw further to prevent screw head prominence.

When placing headed screws, a washer may be used to provide additional contact area with the bone. Washers are laser marked to indicate which side must be in contact with the screw head.

Final screw placement should be checked using image intensification. Repeat as necessary for additional screws.

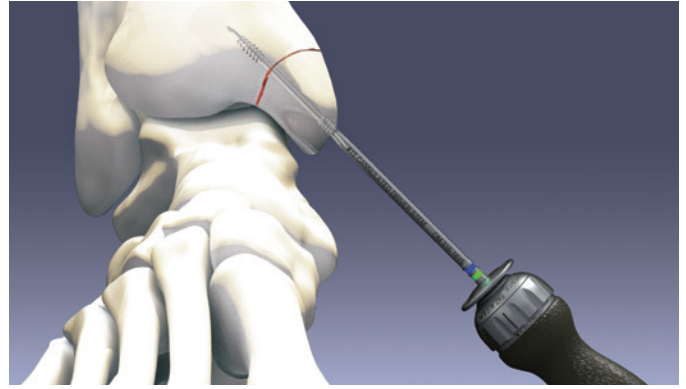

4.5 mm Screws and 5.5 mm Screws

Part Number	Description
316-1615	#15 Self-Retaining Cannulated Driver, Standard AO Quick Release
320-2800	Ratcheting Driver Handle

REDUCTION TOOL - Headless screws can be inserted using the system's reduction tool. Refer to pages 5-6 for reduction tool instructions.

Midsized Reduction Tool

316-1620	4.5/5.5 mm Headless Compression Screw Reduction Tool
----------	--

Surgical Technique

Calcaneal Osteotomy

1. Insert Guide Wire

Place the guide wire/ drill guide through a stab incision and insert the guide wire into the bone to the appropriate depth. Use image intensification to verify the guide wire placement. Proper position of guide wire is critical for the screw placement.

When placing more than one screw, ensure that subsequent guide wires do not interfere with other implants.

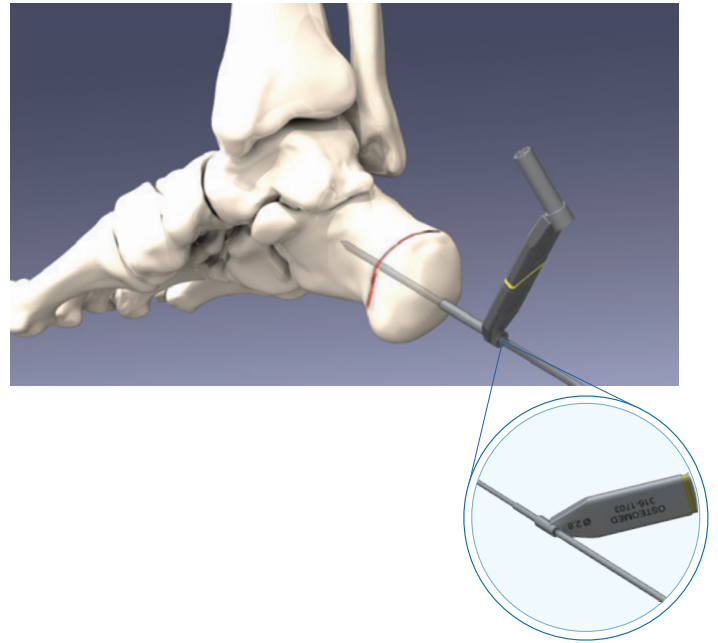

6.5 mm Screws

Part Number	Description
316-1701	2.8 mm x 230 mm Smooth Guide Wire
316-1702	2.8 mm x 230 mm Threaded Guide Wire
316-1703	2.8 mm/4.8 mm Guide Wire/Drill Guide

2. Screw Length Measurement

Place depth gauge over the guide wire until the depth gauge tip is positioned directly against the bone. The proximal end of the guide wire will indicate the screw length required. Subtract any anticipated interfragmentary compression resulting from screw insertion.

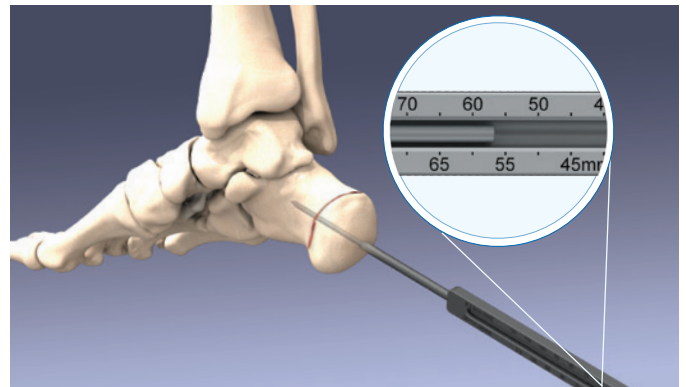

6.5 mm Screws

316-1701	2.8 mm x 230 mm Smooth Guide Wire
316-1702	2.8 mm x 230 mm Threaded Guide Wire
316-1714	Large Depth Gauge

Surgical Technique

Calcaneal Osteotomy (Cont.)

3. Pre-Drilling and Tapping (Optional)

The ExtremiFix Midsize I Large Cannulated Screws are self-drilling and self-tapping. In dense cortical bone, pre-drilling and tapping is recommended.

Place the guide wire/drill guide over the guide wire and drill to the desired depth. Drilling should not go beyond the tip of the guide wire.

When tapping, insert the cannulated bone tap over the guide wire and manually rotate the bone tap until desired depth is reached.

Note: The proximal cortex drill sleeve has been designed to nest with the guide wire/drill guide. Countersinking can be performed with or without the proximal cortex drill sleeve. If using the proximal cortex drill sleeve, assemble the proximal cortex sleeve and guide wire/drill guide prior to drilling.

6.5 mm Screws

Part Number	Description
316-1704	4.8 mm Cannulated Drill, Large AO Quick Release
316-1703	2.8 mm/4.8 mm Guide Wire/Drill Guide
316-1712	6.5 mm Cannulated Tap, Large AO Quick Release

4. Countersinking

A Countersink is available for headless screws. Countersinking should be performed manually.

Place the cannulated countersink or proximal cortex drill over the guide wire to create a recess on the proximal cortex.

Note: Overall screw length is measured from the top of the screw head to the tip of the screw. The head height should be considered when countersinking

6.5 mm Screws

316-1708	6.0 mm Cannulated Proximal Cortex Drill, Large AO Quick Release
316-1721	Large Proximal Cortex Drill Sleeve

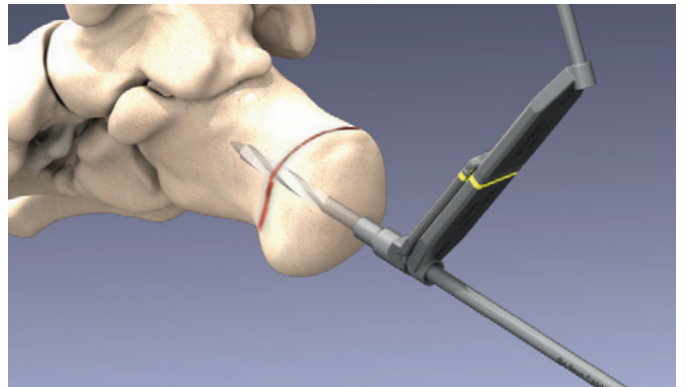
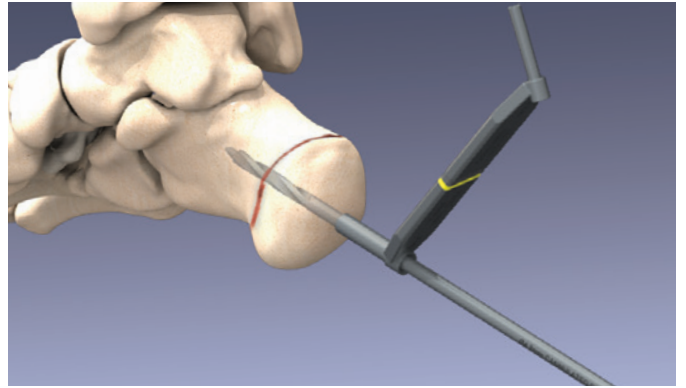

Optional - Proximal cortex drill sleeve and guide wire/drill guide assembly.

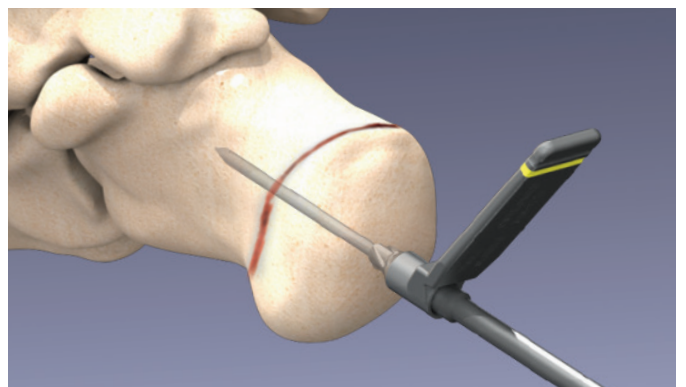
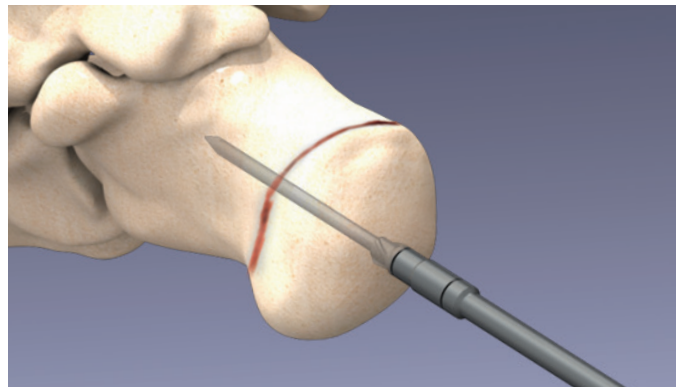

Optional - Countersink used with proximal cortex sleeve.

Surgical Technique

Calcaneal Osteotomy (Cont.)

5. Screw Placement

Select the appropriate screw length and insert screw over the guide wire using the cannulated driver stem and ratcheting handle. Advance the screw head until fully seated with the surface of the bone.

When inserting headless screws in an oblique orientation, it may be necessary to drive screw further to prevent screw head prominence.

Final screw placement should be checked using image intensification. Repeat as necessary for additional screws.

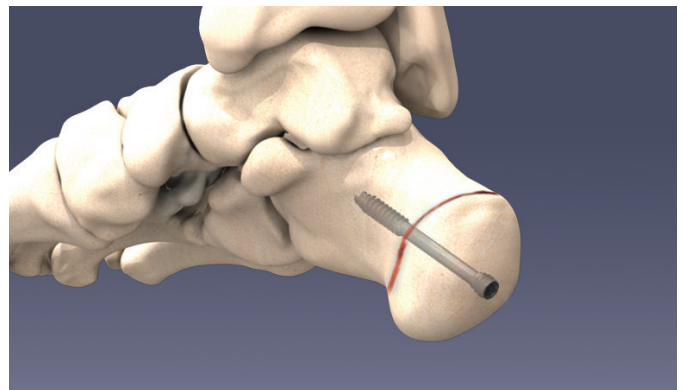
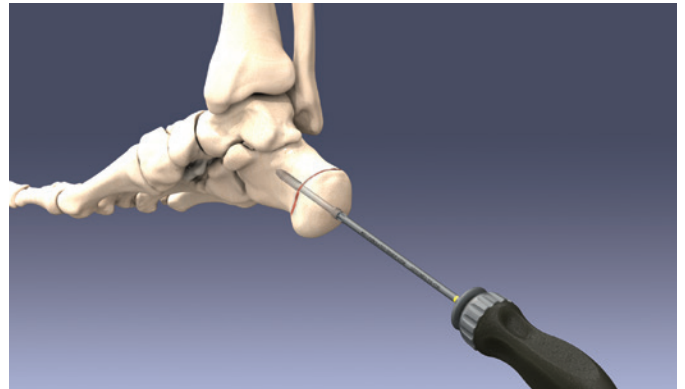

6.5 mm Screws

Part Number	Description
316-1730	#30 Self-Retaining Cannulated Driver, Large AO Quick Release
316-1740	Ratcheting Driver Handle, Large AO

REDUCTION TOOL - Headless screws can be inserted using the system's reduction tool. Refer to pages 5-6 for reduction tool instructions.

Large Reduction Tool

316-1720	Large Headless Compression Screw Reduction Tool
----------	---

Ordering Information

Midsize Implants



4.5 mm Headless Short Thread Screws

- 317-4520 4.5 x 20 mm Cannulated Headless Compression Screw, Short Thread
- 317-4522 4.5 x 22 mm Cannulated Headless Compression Screw, Short Thread
- 317-4524 4.5 x 24 mm Cannulated Headless Compression Screw, Short Thread
- 317-4526 4.5 x 26 mm Cannulated Headless Compression Screw, Short Thread
- 317-4528 4.5 x 28 mm Cannulated Headless Compression Screw, Short Thread
- 317-4530 4.5 x 30 mm Cannulated Headless Compression Screw, Short Thread
- 317-4532 4.5 x 32 mm Cannulated Headless Compression Screw, Short Thread
- 317-4534 4.5 x 34 mm Cannulated Headless Compression Screw, Short Thread
- 317-4536 4.5 x 36 mm Cannulated Headless Compression Screw, Short Thread
- 317-4538 4.5 x 38 mm Cannulated Headless Compression Screw, Short Thread
- 317-4540 4.5 x 40 mm Cannulated Headless Compression Screw, Short Thread
- 317-4542 4.5 x 42 mm Cannulated Headless Compression Screw, Short Thread
- 317-4544 4.5 x 44 mm Cannulated Headless Compression Screw, Short Thread
- 317-4546 4.5 x 46 mm Cannulated Headless Compression Screw, Short Thread
- 317-4548 4.5 x 48 mm Cannulated Headless Compression Screw, Short Thread
- 317-4550 4.5 x 50 mm Cannulated Headless Compression Screw, Short Thread
- 317-4555 4.5 x 55 mm Cannulated Headless Compression Screw, Short Thread
- 317-4560 4.5 x 60 mm Cannulated Headless Compression Screw, Short Thread
- 317-4565 4.5 x 65 mm Cannulated Headless Compression Screw, Short Thread
- 317-4570 4.5 x 70 mm Cannulated Headless Compression Screw, Short Thread



4.5 mm Headless Long Thread Screws

- 317-4541 4.5 x 40 mm Cannulated Headless Compression Screw, Long Thread
- 317-4543 4.5 x 42 mm Cannulated Headless Compression Screw, Long Thread
- 317-4545 4.5 x 44 mm Cannulated Headless Compression Screw, Long Thread
- 317-4547 4.5 x 46 mm Cannulated Headless Compression Screw, Long Thread
- 317-4549 4.5 x 48 mm Cannulated Headless Compression Screw, Long Thread
- 317-4551 4.5 x 50 mm Cannulated Headless Compression Screw, Long Thread
- 317-4556 4.5 x 55 mm Cannulated Headless Compression Screw, Long Thread
- 317-4561 4.5 x 60 mm Cannulated Headless Compression Screw, Long Thread
- 317-4566 4.5 x 65 mm Cannulated Headless Compression Screw, Long Thread
- 317-4571 4.5 x 70 mm Cannulated Headless Compression Screw, Long Thread



4.5 mm Headed Short Thread Screws

- 319-4520 4.5 x 20 mm Cannulated Headed Screw, Short Thread
- 319-4522 4.5 x 22 mm Cannulated Headed Screw, Short Thread
- 319-4524 4.5 x 24 mm Cannulated Headed Screw, Short Thread
- 319-4526 4.5 x 26 mm Cannulated Headed Screw, Short Thread
- 319-4528 4.5 x 28 mm Cannulated Headed Screw, Short Thread
- 319-4530 4.5 x 30 mm Cannulated Headed Screw, Short Thread
- 319-4532 4.5 x 32 mm Cannulated Headed Screw, Short Thread
- 319-4534 4.5 x 34 mm Cannulated Headed Screw, Short Thread
- 319-4536 4.5 x 36 mm Cannulated Headed Screw, Short Thread
- 319-4538 4.5 x 38 mm Cannulated Headed Screw, Short Thread
- 319-4540 4.5 x 40 mm Cannulated Headed Screw, Short Thread
- 319-4542 4.5 x 42 mm Cannulated Headed Screw, Short Thread
- 319-4544 4.5 x 44 mm Cannulated Headed Screw, Short Thread
- 319-4546 4.5 x 46 mm Cannulated Headed Screw, Short Thread
- 319-4548 4.5 x 48 mm Cannulated Headed Screw, Short Thread
- 319-4550 4.5 x 50 mm Cannulated Headed Screw, Short Thread
- 319-4555 4.5 x 55 mm Cannulated Headed Screw, Short Thread
- 319-4560 4.5 x 60 mm Cannulated Headed Screw, Short Thread
- 319-4565 4.5 x 65 mm Cannulated Headed Screw, Short Thread
- 319-4570 4.5 x 70 mm Cannulated Headed Screw, Short Thread



4.5 mm Headed Long Thread Screws

- 319-4541 4.5 x 40 mm Cannulated Headed Screw, Long Thread
- 319-4543 4.5 x 42 mm Cannulated Headed Screw, Long Thread
- 319-4545 4.5 x 44 mm Cannulated Headed Screw, Long Thread
- 319-4547 4.5 x 46 mm Cannulated Headed Screw, Long Thread
- 319-4549 4.5 x 48 mm Cannulated Headed Screw, Long Thread
- 319-4551 4.5 x 50 mm Cannulated Headed Screw, Long Thread
- 319-4556 4.5 x 55 mm Cannulated Headed Screw, Long Thread
- 319-4561 4.5 x 60 mm Cannulated Headed Screw, Long Thread
- 319-4566 4.5 x 65 mm Cannulated Headed Screw, Long Thread
- 319-4571 4.5 x 70 mm Cannulated Headed Screw, Long Thread



Washer

- 316-0325 4.5 mm Screw Washer

Ordering Information

Midsize Implants



5.5 mm Headless Short Thread Screws

317-5520	5.5 x 20 mm Cannulated Headless Compression Screw, Short Thread
317-5522	5.5 x 22 mm Cannulated Headless Compression Screw, Short Thread
317-5524	5.5 x 24 mm Cannulated Headless Compression Screw, Short Thread
317-5526	5.5 x 26 mm Cannulated Headless Compression Screw, Short Thread
317-5528	5.5 x 28 mm Cannulated Headless Compression Screw, Short Thread
317-5530	5.5 x 30 mm Cannulated Headless Compression Screw, Short Thread
317-5532	5.5 x 32 mm Cannulated Headless Compression Screw, Short Thread
317-5534	5.5 x 34 mm Cannulated Headless Compression Screw, Short Thread
317-5536	5.5 x 36 mm Cannulated Headless Compression Screw, Short Thread
317-5538	5.5 x 38 mm Cannulated Headless Compression Screw, Short Thread
317-5540	5.5 x 40 mm Cannulated Headless Compression Screw, Short Thread
317-5542	5.5 x 42 mm Cannulated Headless Compression Screw, Short Thread
317-5544	5.5 x 44 mm Cannulated Headless Compression Screw, Short Thread
317-5546	5.5 x 46 mm Cannulated Headless Compression Screw, Short Thread
317-5548	5.5 x 48 mm Cannulated Headless Compression Screw, Short Thread
317-5550	5.5 x 50 mm Cannulated Headless Compression Screw, Short Thread
317-5555	5.5 x 55 mm Cannulated Headless Compression Screw, Short Thread
317-5560	5.5 x 60 mm Cannulated Headless Compression Screw, Short Thread
317-5565	5.5 x 65 mm Cannulated Headless Compression Screw, Short Thread
317-5570	5.5 x 70 mm Cannulated Headless Compression Screw, Short Thread
317-5575	5.5 x 75 mm Cannulated Headless Compression Screw, Short Thread
317-5580	5.5 x 80 mm Cannulated Headless Compression Screw, Short Thread



5.5 mm Headless Long Thread Screws

317-5541	5.5 x 40 mm Cannulated Headless Compression Screw, Long Thread
317-5543	5.5 x 42 mm Cannulated Headless Compression Screw, Long Thread
317-5545	5.5 x 44 mm Cannulated Headless Compression Screw, Long Thread
317-5547	5.5 x 46 mm Cannulated Headless Compression Screw, Long Thread
317-5549	5.5 x 48 mm Cannulated Headless Compression Screw, Long Thread
317-5551	5.5 x 50 mm Cannulated Headless Compression Screw, Long Thread
317-5556	5.5 x 55 mm Cannulated Headless Compression Screw, Long Thread
317-5561	5.5 x 60 mm Cannulated Headless Compression Screw, Long Thread
317-5566	5.5 x 65 mm Cannulated Headless Compression Screw, Long Thread
317-5571	5.5 x 70 mm Cannulated Headless Compression Screw, Long Thread
317-5576	5.5 x 75 mm Cannulated Headless Compression Screw, Long Thread
317-5581	5.5 x 80 mm Cannulated Headless Compression Screw, Long Thread



5.5 mm Headed Short Thread Screws

319-5520	5.5 x 20 mm Cannulated Headed Screw, Short Thread
319-5522	5.5 x 22 mm Cannulated Headed Screw, Short Thread
319-5524	5.5 x 24 mm Cannulated Headed Screw, Short Thread
319-5526	5.5 x 26 mm Cannulated Headed Screw, Short Thread
319-5528	5.5 x 28 mm Cannulated Headed Screw, Short Thread
319-5530	5.5 x 30 mm Cannulated Headed Screw, Short Thread
319-5532	5.5 x 32 mm Cannulated Headed Screw, Short Thread
319-5534	5.5 x 34 mm Cannulated Headed Screw, Short Thread
319-5536	5.5 x 36 mm Cannulated Headed Screw, Short Thread
319-5538	5.5 x 38 mm Cannulated Headed Screw, Short Thread
319-5540	5.5 x 40 mm Cannulated Headed Screw, Short Thread
319-5542	5.5 x 42 mm Cannulated Headed Screw, Short Thread
319-5544	5.5 x 44 mm Cannulated Headed Screw, Short Thread
319-5546	5.5 x 46 mm Cannulated Headed Screw, Short Thread
319-5548	5.5 x 48 mm Cannulated Headed Screw, Short Thread
319-5550	5.5 x 50 mm Cannulated Headed Screw, Short Thread
319-5555	5.5 x 55 mm Cannulated Headed Screw, Short Thread
319-5560	5.5 x 60 mm Cannulated Headed Screw, Short Thread
319-5565	5.5 x 65 mm Cannulated Headed Screw, Short Thread
319-5570	5.5 x 70 mm Cannulated Headed Screw, Short Thread
319-5575	5.5 x 75 mm Cannulated Headed Screw, Short Thread
319-5580	5.5 x 80 mm Cannulated Headed Screw, Short Thread



5.5 mm Headed Long Thread Screws

319-5541	5.5 x 40 mm Cannulated Headed Screw, Long Thread
319-5543	5.5 x 42 mm Cannulated Headed Screw, Long Thread
319-5545	5.5 x 44 mm Cannulated Headed Screw, Long Thread
319-5547	5.5 x 46 mm Cannulated Headed Screw, Long Thread
319-5549	5.5 x 48 mm Cannulated Headed Screw, Long Thread
319-5551	5.5 x 50 mm Cannulated Headed Screw, Long Thread
319-5556	5.5 x 55 mm Cannulated Headed Screw, Long Thread
319-5561	5.5 x 60 mm Cannulated Headed Screw, Long Thread
319-5566	5.5 x 65 mm Cannulated Headed Screw, Long Thread
319-5571	5.5 x 70 mm Cannulated Headed Screw, Long Thread
319-5576	5.5 x 75 mm Cannulated Headed Screw, Long Thread
319-5581	5.5 x 80 mm Cannulated Headed Screw, Long Thread



Washer

316-0326 5.5 mm Screw Washer

Ordering Information

Large Implants



6.5 mm Headless Short Thread Screws

317-6540	6.5 X 40 mm Cannulated Headless Compression Screw, 16 mm Thread
317-6545	6.5 X 45 mm Cannulated Headless Compression Screw, 16 mm Thread
317-6550	6.5 X 50 mm Cannulated Headless Compression Screw, 16 mm Thread
317-6555	6.5 X 55 mm Cannulated Headless Compression Screw, 16 mm Thread
317-6560	6.5 X 60 mm Cannulated Headless Compression Screw, 16 mm Thread
317-6565	6.5 X 65 mm Cannulated Headless Compression Screw, 16 mm Thread
317-6570	6.5 X 70 mm Cannulated Headless Compression Screw, 16 mm Thread
317-6575	6.5 X 75 mm Cannulated Headless Compression Screw, 16 mm Thread
317-6580	6.5 X 80 mm Cannulated Headless Compression Screw, 16 mm Thread
317-6585	6.5 X 85 mm Cannulated Headless Compression Screw, 16 mm Thread
317-6590	6.5 X 90 mm Cannulated Headless Compression Screw, 16 mm Thread
317-6595	6.5 X 95 mm Cannulated Headless Compression Screw, 16 mm Thread
317-6600	6.5 X 100 mm Cannulated Headless Compression Screw, 16 mm Thread
317-6605	6.5 X 105 mm Cannulated Headless Compression Screw, 16 mm Thread
317-6610	6.5 X 110 mm Cannulated Headless Compression Screw, 16 mm Thread
317-6615	6.5 X 115 mm Cannulated Headless Compression Screw, 16 mm Thread
317-6620	6.5 X 120 mm Cannulated Headless Compression Screw, 16 mm Thread



6.5 mm Headless Long Thread Screws

317-6546	6.5 X 45 mm Cannulated Headless Compression Screw, 32 mm Thread
317-6551	6.5 X 50 mm Cannulated Headless Compression Screw, 32 mm Thread
317-6556	6.5 X 55 mm Cannulated Headless Compression Screw, 32 mm Thread
317-6561	6.5 X 60 mm Cannulated Headless Compression Screw, 32 mm Thread
317-6566	6.5 X 65 mm Cannulated Headless Compression Screw, 32 mm Thread
317-6571	6.5 X 70 mm Cannulated Headless Compression Screw, 32 mm Thread
317-6576	6.5 X 75 mm Cannulated Headless Compression Screw, 32 mm Thread
317-6581	6.5 X 80 mm Cannulated Headless Compression Screw, 32 mm Thread
317-6586	6.5 X 85 mm Cannulated Headless Compression Screw, 32 mm Thread
317-6591	6.5 X 90 mm Cannulated Headless Compression Screw, 32 mm Thread
317-6596	6.5 X 95 mm Cannulated Headless Compression Screw, 32 mm Thread
317-6601	6.5 X 100 mm Cannulated Headless Compression Screw, 32 mm Thread
317-6606	6.5 X 105 mm Cannulated Headless Compression Screw, 32 mm Thread
317-6611	6.5 X 110 mm Cannulated Headless Compression Screw, 32 mm Thread
317-6616	6.5 X 115 mm Cannulated Headless Compression Screw, 32 mm Thread
317-6621	6.5 X 120 mm Cannulated Headless Compression Screw, 32 mm Thread

Ordering Information

Midsize Instrumentation

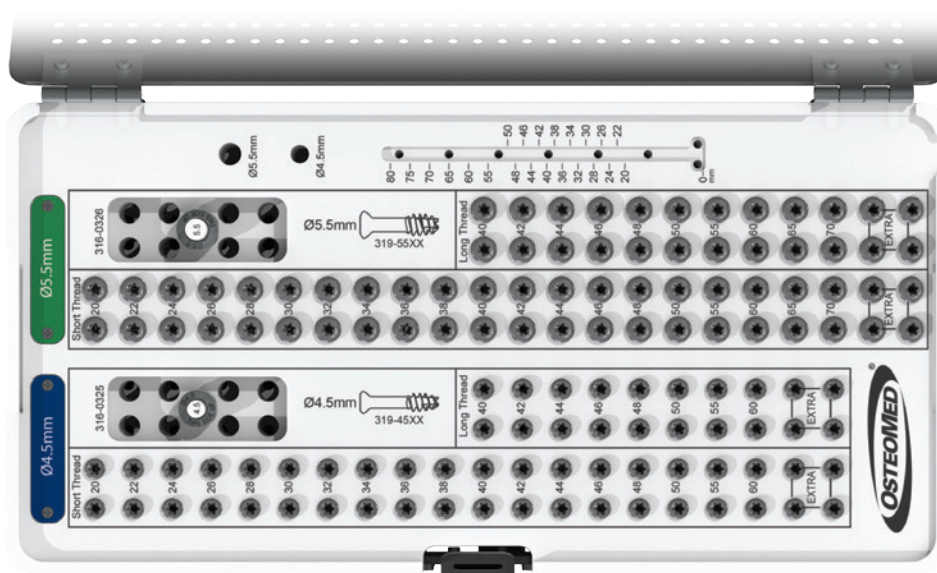

316-1803 ExtremiFix Midsize, 4.5 mm/5.5 mm Headed Screw Module

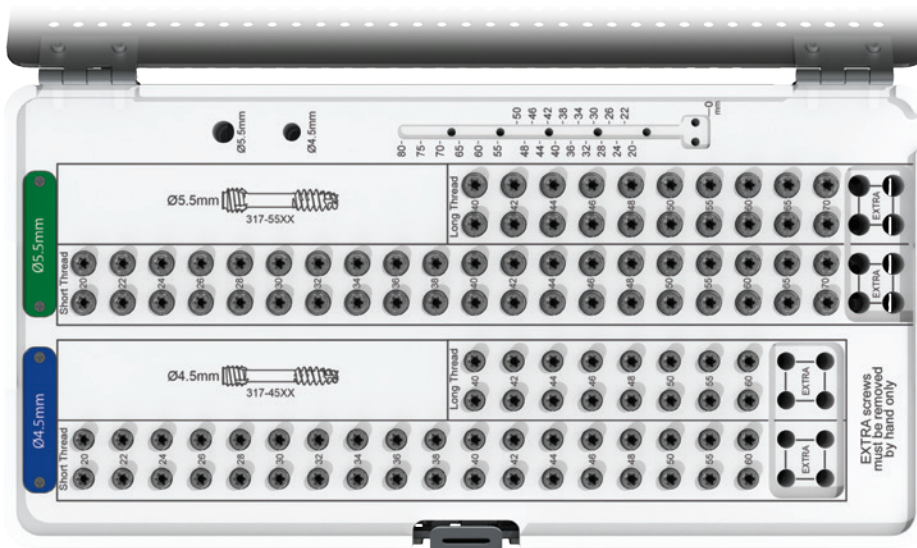

316-1804 ExtremiFix Midsize, 4.5 mm/5.5 mm Headless Screw Module

Ordering Information

Midsize Instrumentation

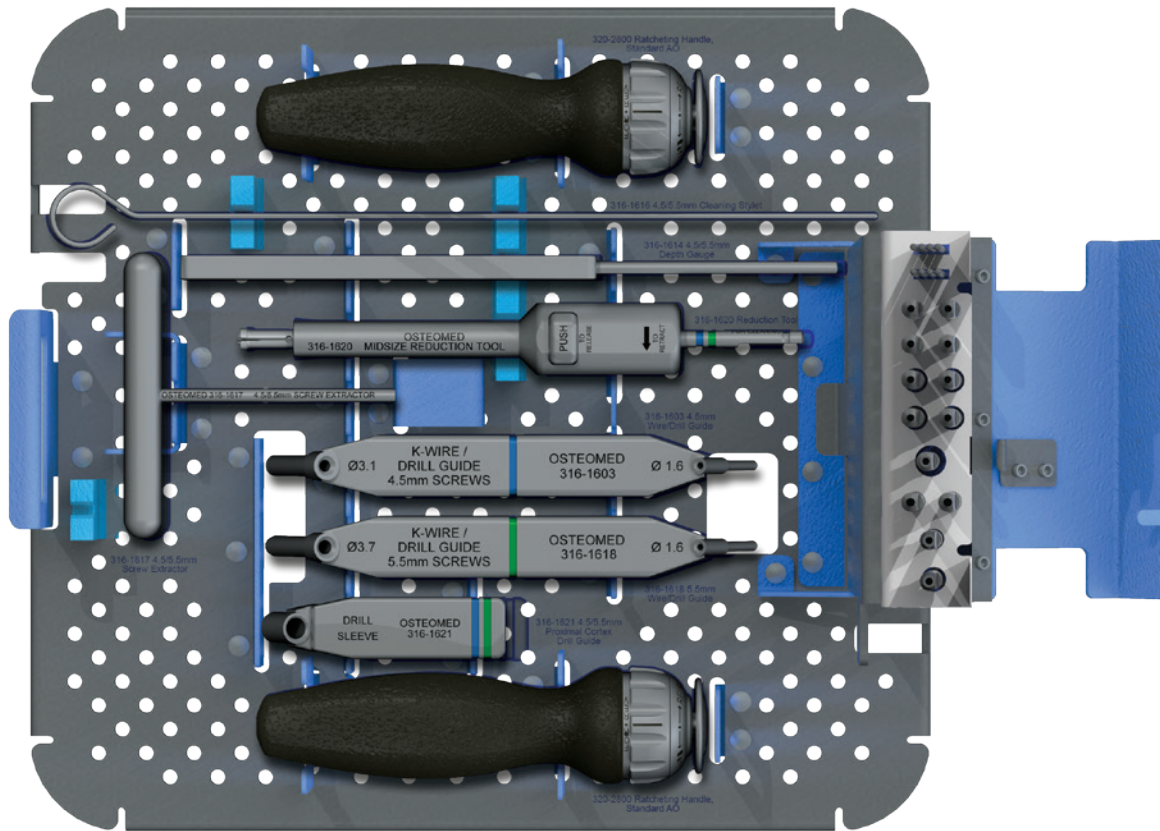

316-1805 ExtremiFix Midsize, 4.5mm/5.5mm ORIF Instrument Tray (Top View)



316-1603 1.6 mm/3.1 mm Guide Wire and Drill Guide



316-1618 1.6 mm/3.7 mm Guide Wire and Drill Guide



316-1621 4.5/5.5 mm Proximal Cortex Drill Sleeve

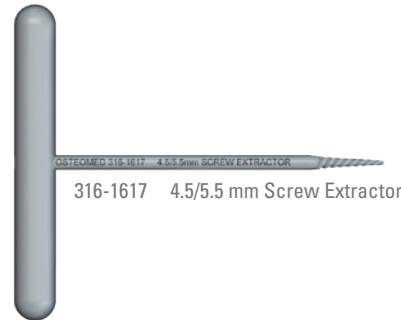

316-1617 4.5/5.5 mm Screw Extractor



316-1614 4.5/5.5 mm Depth Gauge



316-1620 4.5/5.5 mm Headless Compression Screw Reduction Tool



320-2800 Ratcheting Driver Handle, Standard AO



316-1616 4.5/5.5 mm Cleaning Stylet

Ordering Information

Midsize Instrumentation

316-1805 ExtremiFix Midsize, 4.5mm/5.5mm Drill and Driver Organizer (Open View)

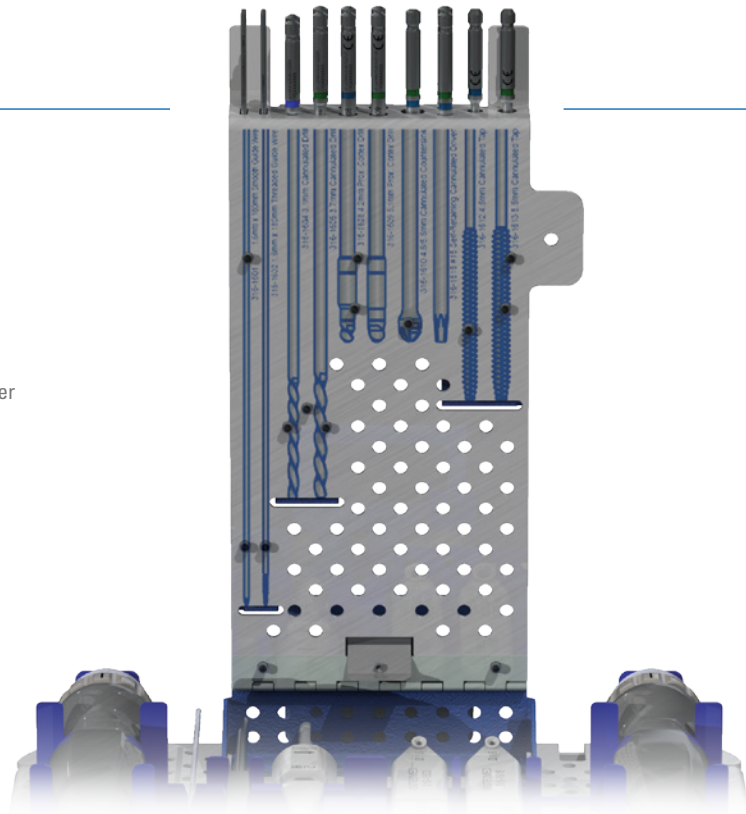

316-1601 1.6 mm x 180 mm Smooth Guide Wire



316-1602 1.6 mm x 180 mm Threaded Guide Wire



316-1604 3.1 mm Cannulated Drill, Standard AO Quick Release



316-1605 3.7 mm Cannulated Drill, Standard AO Quick Release



316-1608 4.2 mm Cannulated Proximal Cortex Drill, Standard AO Quick Release



316-1609 5.1 mm Cannulated Proximal Cortex Drill, Standard AO Quick Release



316-1615 #15 Self-Retaining Cannulated Driver, Standard AO Quick Release



316-1610 4.5/5.5 mm Cannulated Countersink, Standard AO Quick Release



316-1612 4.5 mm Cannulated Tap, Standard AO Quick Release

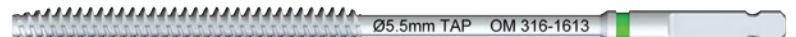

316-1613 5.5 mm Cannulated Tap, Standard AO Quick Release

Ordering Information

Large Instrumentation

316-1905 ExtremiFix Large, Large Screw ORIF Drill and Driver Organizer (Open View)

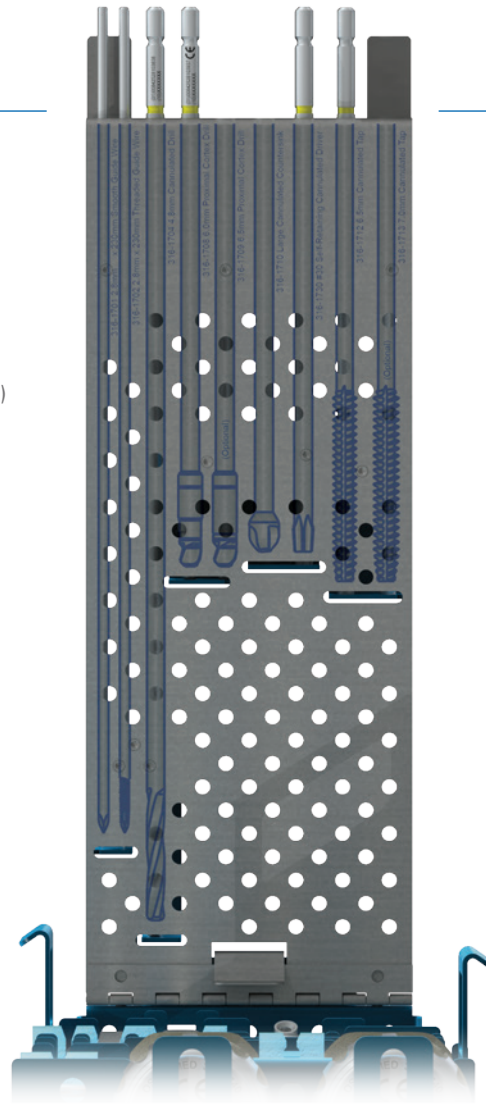

316-1701 2.8 mm x 230 mm Smooth Guide Wire



316-1702 2.8 mm x 230 mm Threaded Guide Wire



316-1704 4.8 mm Cannulated Drill, Large AO Quick Release



316-1708 6.0 mm Cannulated Proximal Cortex Drill, Large AO Quick Release



316-1730 #30 Self-Retaining Cannulated Driver, Large AO Quick Release



316-1712 6.5 mm Cannulated Tap, Large AO Quick Release

System Tray

Midsize Instrument Tray

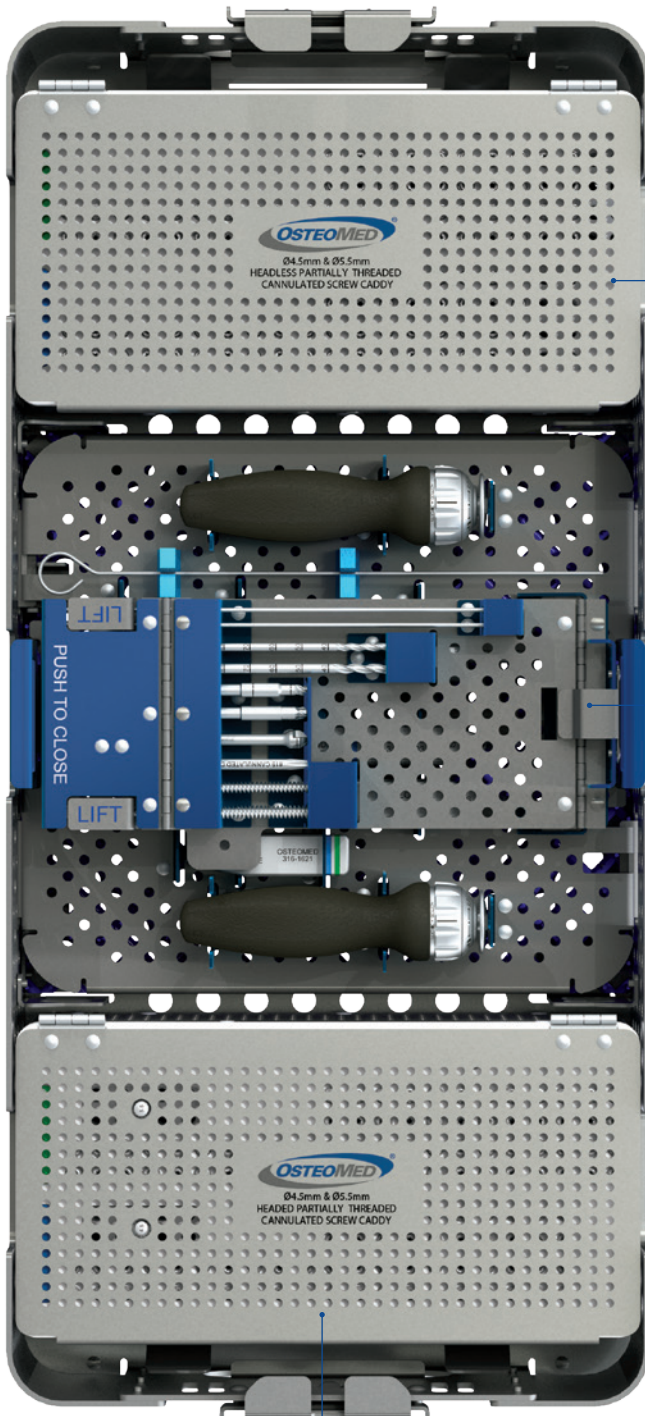

316-1803
ExtremiFix Midsize, 4.5 mm/5.5 mm
Headed Screw Module

316-1804
ExtremiFix Midsize, 4.5 mm/5.5 mm
Headless Screw Module

316-1805
ExtremiFix Midsize, 4.5mm/5.5mm ORIF
Instrument Tray

316-1801
ExtremiFix Midsize, 4.5mm/5.5
mm Screw System Tray Lid

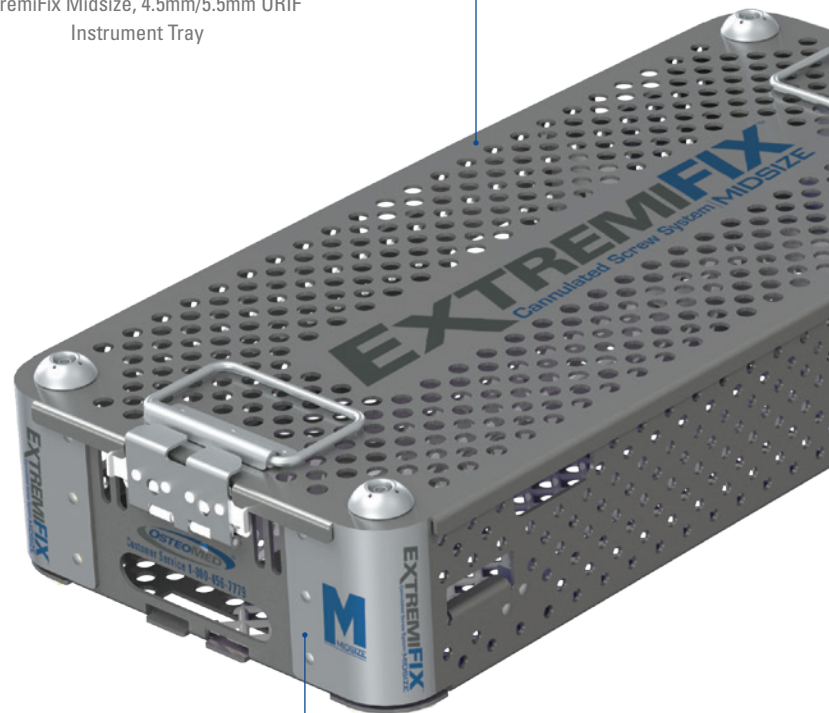

316-1802
ExtremiFix Midsize, 4.5mm/5.5
mm Screw System Tray Base

System Tray

Large Instrument Tray

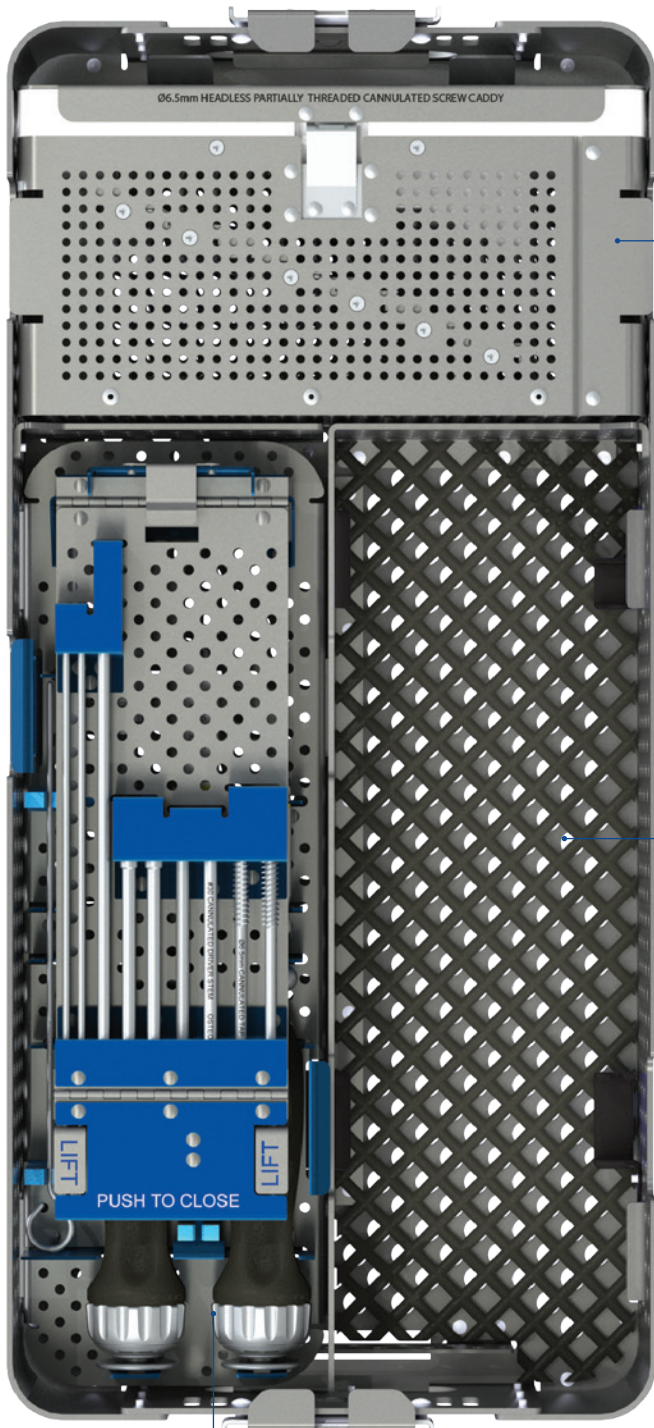

316-1907
ExtremiFix Large,
6.5 mm Headless
Screw Module

316-1901
ExtremiFix Large,
Large Screw System Tray Lid

Auxiliary Area

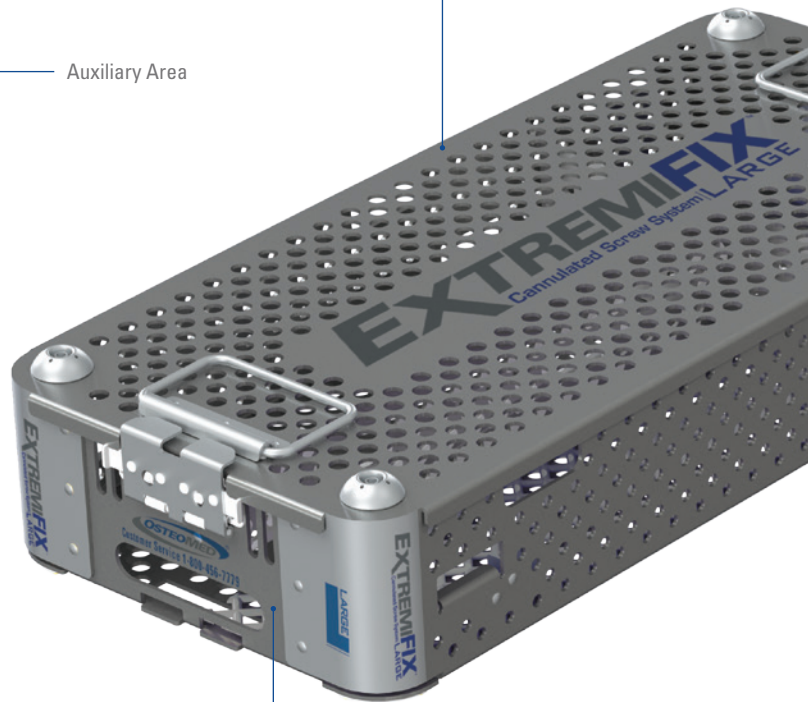

316-1902
ExtremiFix Large,
Large Screw System Tray Base

316-1905
ExtremiFix Large,
Large Screw ORIF
Instrument Tray

OsteoMed Products



ExtremiFix Headless Cannulated Screws



ExtremiFix Cannulated Screws



Large Cannulated Screws



ExtremiFuse

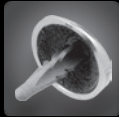

EnCompass



EnCompass Lessers



Hemi



ReFlexion



InterPhlex



Talar-Fit

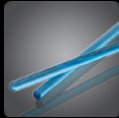

Inion

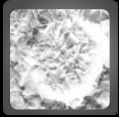

OsteoVationEX

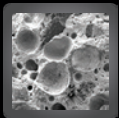

OsteoVation QWIK



OSTEOMED

3885 Arapaho Rd.
Addison, TX 75001
Customer Service: 800.456.7779
Outside the U.S.: 001.972.677.4600
Fax: 800.390.2620
Fax Outside the U.S.: 001.972.677.4709
E-mail: customer.service@osteomed.com
www.osteomed.com